



Care Packs



**Comfort Pack**

Care Package in Times of Isolation

# DIY

## GUIDE

# 1

## **DISINFECTANT STATION**

PREPARATION GUIDE

# 2

## **STORAGE PARTS FOR THE DISINFECTANT STATION**

PREPARATION GUIDE

# How to use the disinfectant station?

disinfection station / upon leaving home / upon arrival

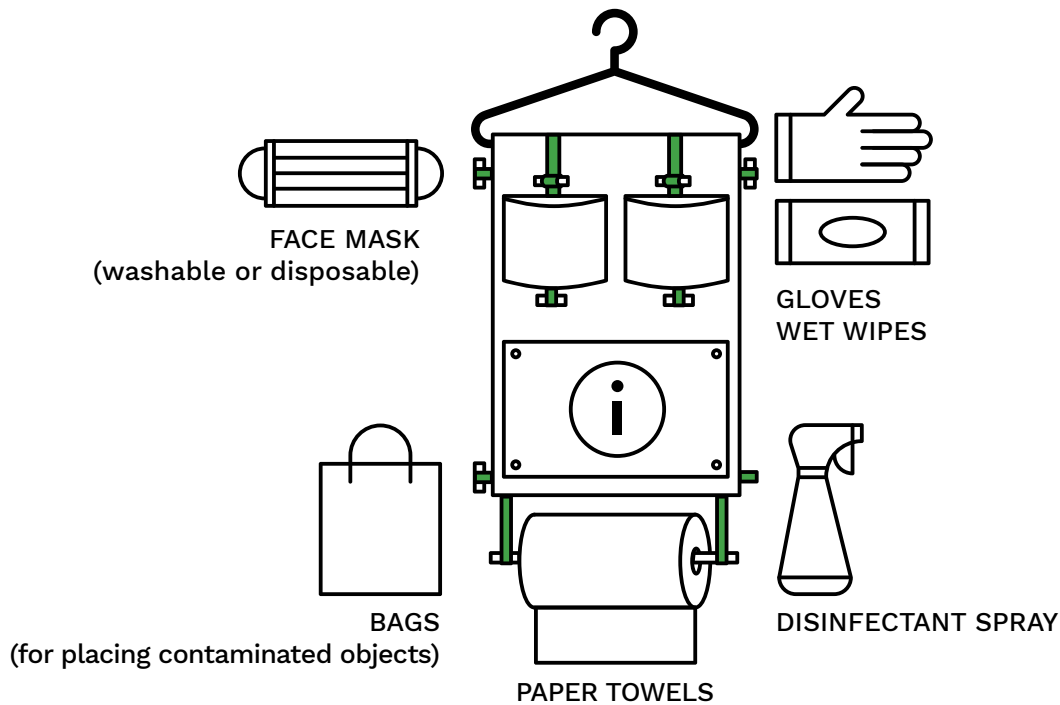

In the present pandemic situation proper disinfection and the use of protective measures are important especially when leaving home and upon arrival. With the help of this guide a washable, easily usable disinfection station can be prepared that may be of help when following the basic principles of disinfection, specifically for the elderly. Hung around the entrance door the station helps to safely store equipment that are necessary for disinfection.

The parts hanging on the side are suitable for storing clean masks, gloves and the bags to contain contaminated protective equipment.

The lower handle on the right serves to store a smaller disinfectant spray. The small spray bottle may be fixed there by its neck and can be used with one hand as well.

The lower, longer bar is suitable for storing a roll of paper towel in case when upon arrival something has to be wiped off immediately. This part is suitable to store other objects, such as gloves, spare masks, etc.

In the middle of the station hanging parts serve to keep the pockets hung on them. In these pockets masks, gloves and other disinfectants can be stored.

The lower, free part of the organizer is for keeping an information sheet (see attachment) that summarizes the protocol for leaving and returning home. When printed on a piece of paper, size A4, this information sheet may be attached to the station by using four pins to fix it at the corners.

**Important!** When placing the organizer by the entrance please make sure that it is out of the reach for children. It should not be in contact with any other articles for personal use. This way the possibly infected objects may be effectively isolated. At the end of this guide there is a short guide for washing the organizer. It is important to comply with these protocols and this equipment may be effectively used daily during this extra-ordinary situation.

# 1

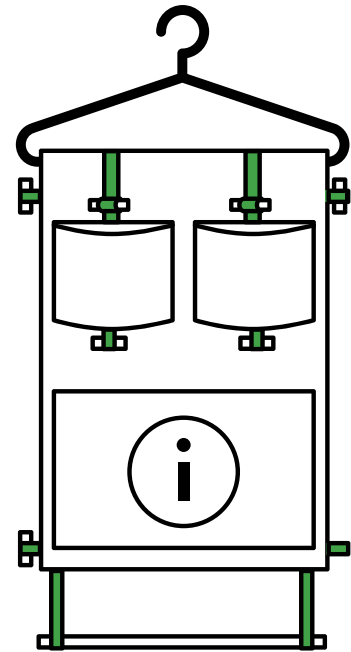

## DISINFECTANT STATION

### PREPARATION GUIDE

#### Things you will need

- 1 textile of 38x54 cm in size, washable at 60 Celsius (this will serve as the front piece of the station)-we have calculated the extra material needed for sewing
- 1 textile of 38x54 cm in size, washable at 60 Celsius (this will serve as the back piece of the station)-we have calculated the extra material needed for sewing
- 1 rubber band, 2 cm wide, 132 long (this will serve as a hanging rubber). The whole piece will have to be cut into the following pieces:
  - 4 pieces 8 cm each
  - 2 pieces 14 cm each
  - 2 pieces 36 cm each
- 1 wooden bar or wood stick 78 cm in length (1 cm in diameter). The whole piece will have to be cut into the following pieces:
  - 7 pieces 6 cm each
  - 1 piece 36 cm
- velcro (hook and loop fastener), 31 cm (2cm wide)
- cardboard, size 36x43 cm (to fix the back part of the station)
- sewing machine
- thread
- scissors (for cutting the textile), handsaw (for cutting the wooden material)

# Preparing the station

- 1 —** Cut out the front and the back according to the size below. Cut the rubber band and the velcro into the size listed above.

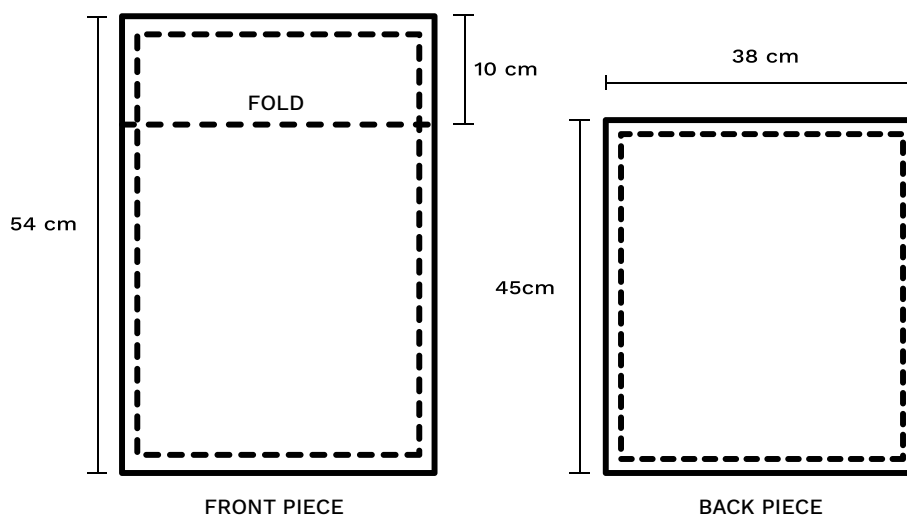

- 2 —** Prepare 5 rubber hooks: fold three 8 cm long pieces and two 14 cm long pieces in half and sew them together 1,2 cm away from the fold.



- 3 —** Prepare the hanging rubber hooks:  
a) Fold 2 cm at the lower end and sew it to its lower part at 1,2 cm.  
b) Pinch 1,2 cm 19cm from the lower end and sew the band together. These handles will hold the short wooden parts.  
c) Folding 2cms above sew the hanging rubber band to the front piece of the front canvas part of the station to the spot you have measured out carefully.

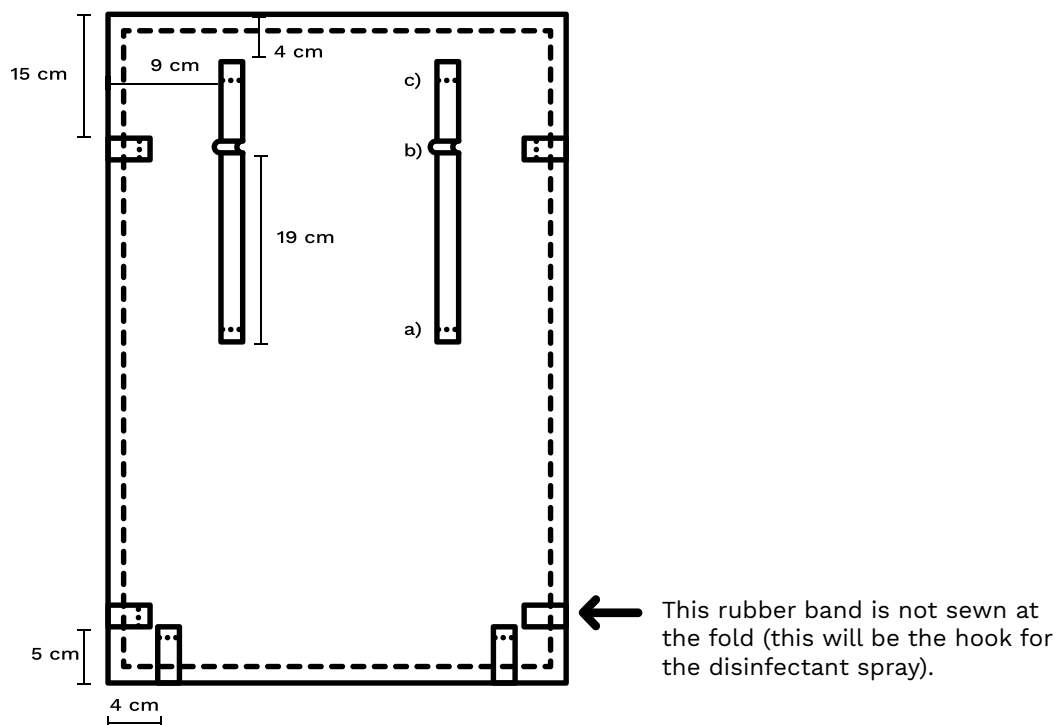

4 —

As the first step sew the velcro's soft side onto the 1cm fold at the top of the front piece at the internal side of the canvas. As the second step sew the velcro's hard side onto the back piece 3cm from the folded top part. You will be able to fix the station to the bottom part of the hanger.

1.

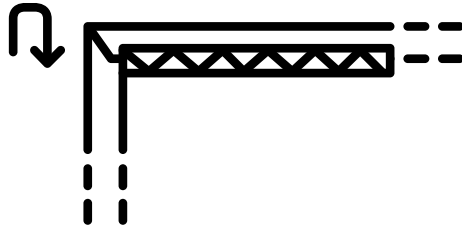

2.

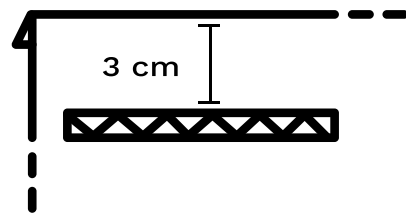

5 —

Turn the two canvas pieces facing each other then turn them inside out. By sliding the cardboard inside you will have the back part stiffened.

1.

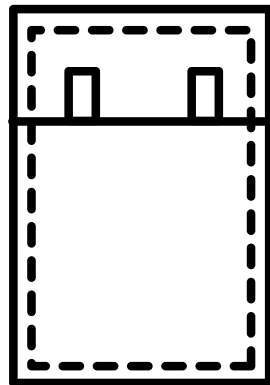

2.

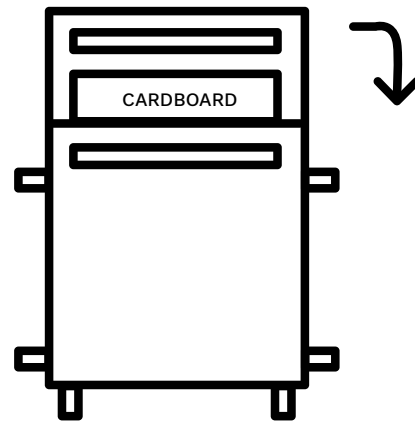

6 —

Slide the 6 cm long wooden parts into the already sewn rubber handles.

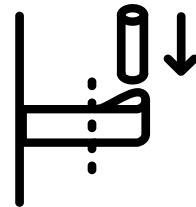

7 —

The station is ready and you can fasten it onto a hanger with the velcro. The basis for the organizer is ready!

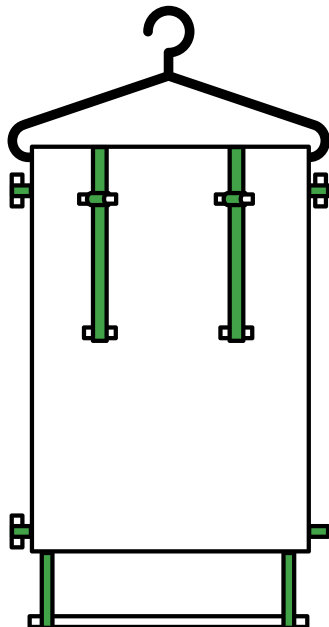

**Ready? Super!**  
**And now onto the storage pockets!**

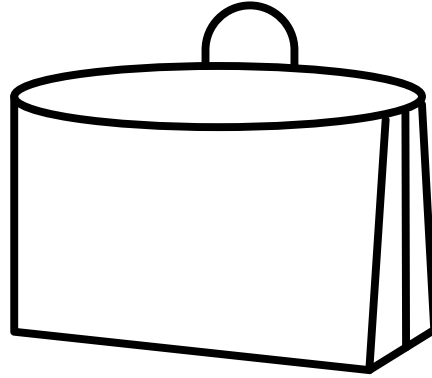

# 2

## **STORAGE POCKETS**

### **PREPARATION GUIDE FOR 2 STORAGE POCKETS**

#### Things you will need

- 8 pieces of textile, 18x15 cm each (for the 2 hanging storage pockets)
- 2 fine rubber strings, 8 cm each (these are the hooks for the pockets, their diameter cca 2mm)
- sewing machine
- thread
- scissors

In the guide we suggest 2 storage pockets. However, if you do not use the information sheet 4 storage pockets can fit onto the station. When preparing the station you can decide which solution you think more practical. In this case you will need double the canvas and the rubber strings listed above.

# Preparing the storage pockets

- 1 —** Sew the small rubber handles by hand to two of the already cut out 8 canvas pieces of identical size (18x15cm) to the longer top part of the pattern in the middle so that the legs of the rubber bands are 3 cm apart from each other.

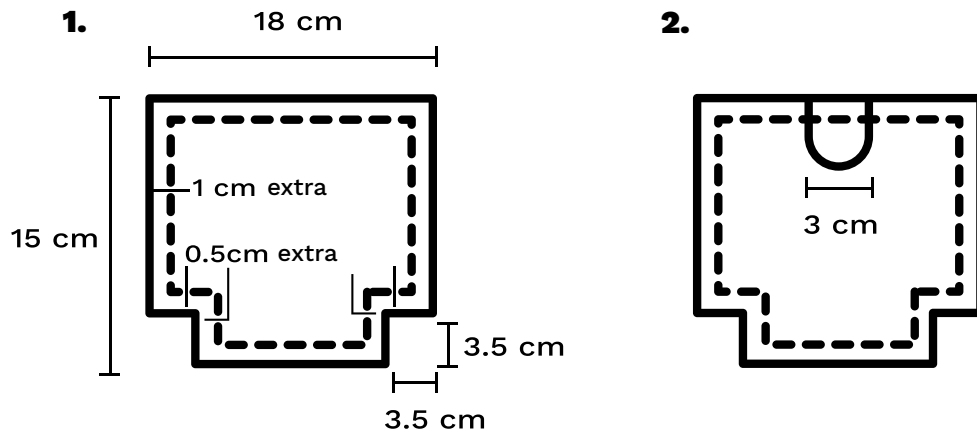

- 2 —** Turn the 4x2 pieces facing each other at the top where you have just sewn the small rubber bands then sew them together just by one line. You will get 4 identically sewn pieces.

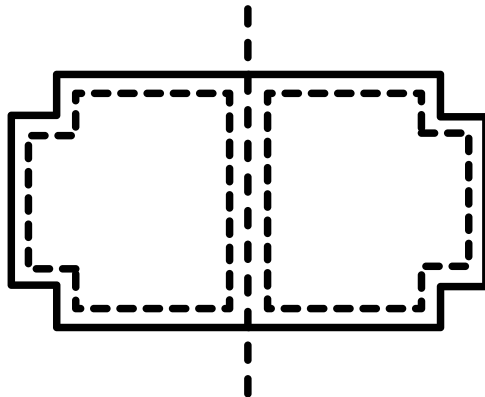

- 3 —** Turn the pairs facing each other by paying attention to have pairs where one piece is with the rubber band and one is without. Sew them together along the broken line leaving the corners out and leaving a small hole at the long end where you will be able to turn the entire pocket inside out.

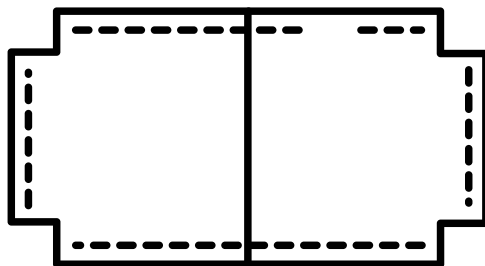

- 4 —** Pinch all the 8 corners together and sew them at 5 mm. You will get little cushions.

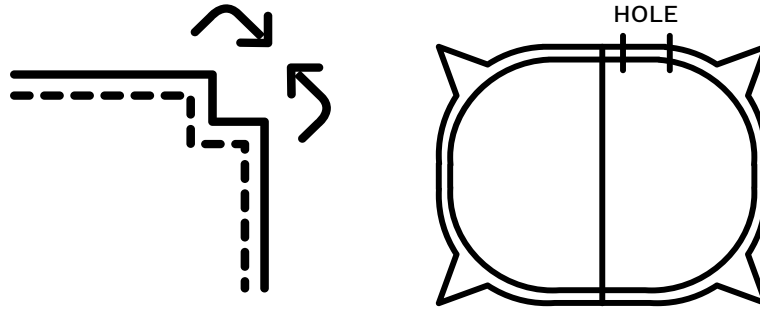

- 5 —** Through the small hole carefully turn the sewn canvas inside out then pinch the hole and sew it from the outside. This will be turned into the external canvas part and will be at the inside part of the lining.

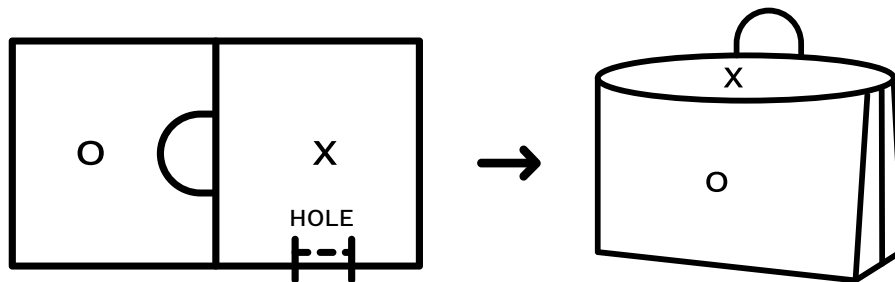

O - EXTERNAL SIDE  
X - INTERNAL SIDE

- 6 —** If the canvas is too wrinkled iron it to make it smooth. Place them on the station hands on top or to a place where it fits best for you.

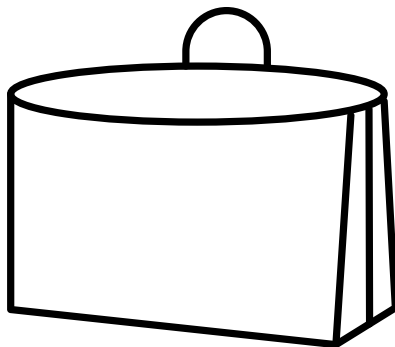

***The disinfectant station is ready for use!  
We hope it will help safe leaving and arrival!***

### **Guide for washing**

*Depending on its use you should wash all parts of the disinfection station at least every two weeks at 60 degrees Celsius!*

#### **Preparing the cleaning of the station**

*Take off the information sheet!*

*Take off the storage pockets!*

*Pull all the wooden parts out and if possible spray them with alcohol for disinfection!*

*Pull the cardboard out from the back!*

*Place them into a bag, and close it!*

*Wash all textile parts in a washing machine at 60 degrees and set the spin at 800 rev.*

*After washing and drying iron the textile parts if they became too wrinkled.*





## Comfort Pack

Care Package in Times of Isolation

# Disclaimer

*We compiled the present contents of this PDF with the greatest care.*

*Information, data, recommendations published on the MOME website and in this PDF serve exclusively as references. MOME is not liable for the information being incomplete, for possible modifications, neither for problems, damages or malformation emerging from unprofessional/inadequate use or application. Application of the Care Packs and individual products recommended in these packs is voluntary and may take place only on one's own responsibility. Information and data presented on the MOME website are recommendations and they do not replace consultation with doctors or nurses. In case you need more information about features, uses of any care pack/product available at the MOME webpage, or perhaps in case you have complaints, please contact us at [segitopakk@mome.hu](mailto:segitopakk@mome.hu).*

*References to other websites on the MOME webpage are also exclusively informative. MOME is not responsible for data and information published at external sites. We cannot influence contents appearing at other websites. Therefore we are not liable for illicit, fake, incorrect or incomplete contents and damage caused by using contents appearing under external sources.*

**[segitopakk.mome.hu](http://segitopakk.mome.hu)**